

AANDUIDING ZONES

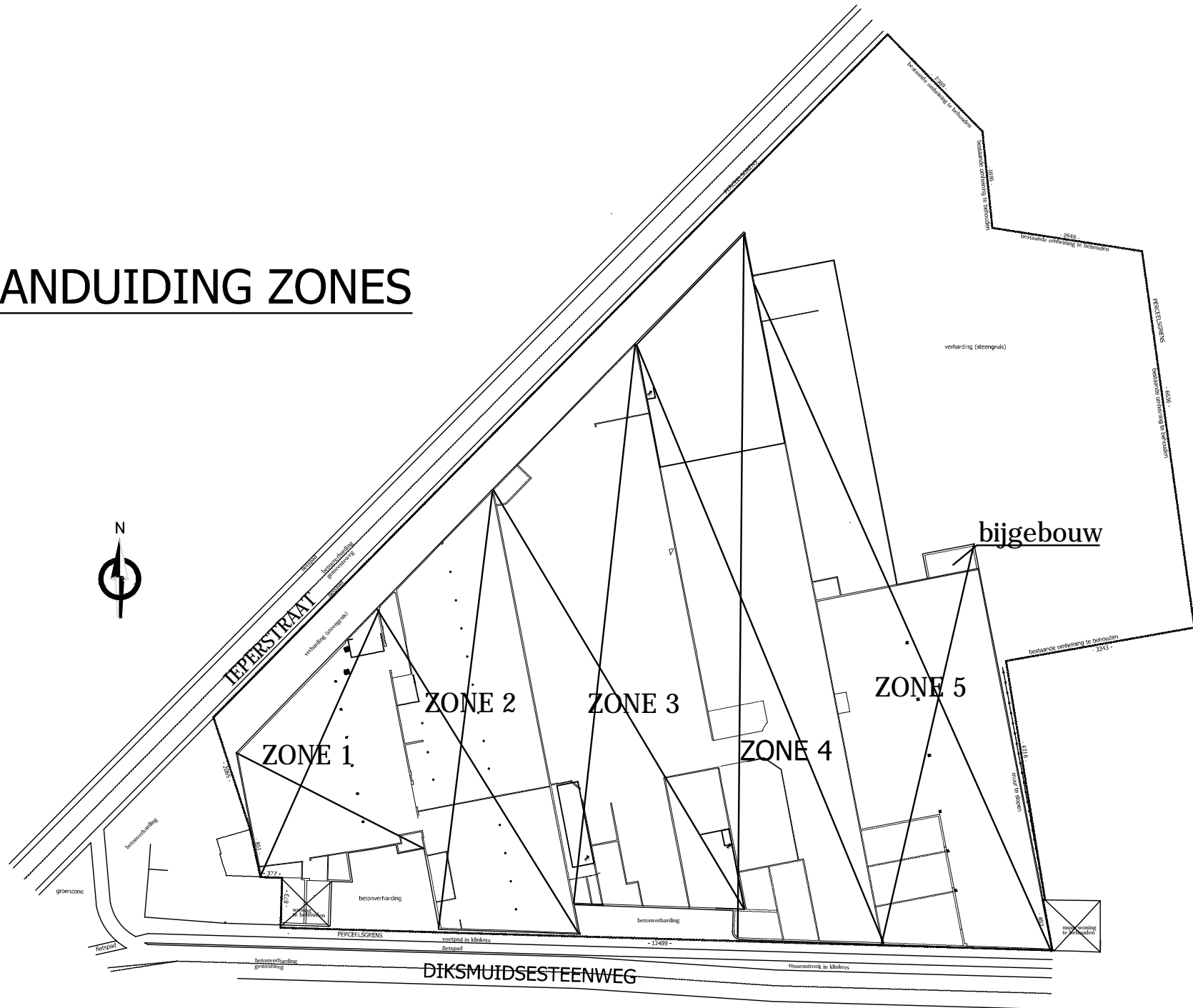

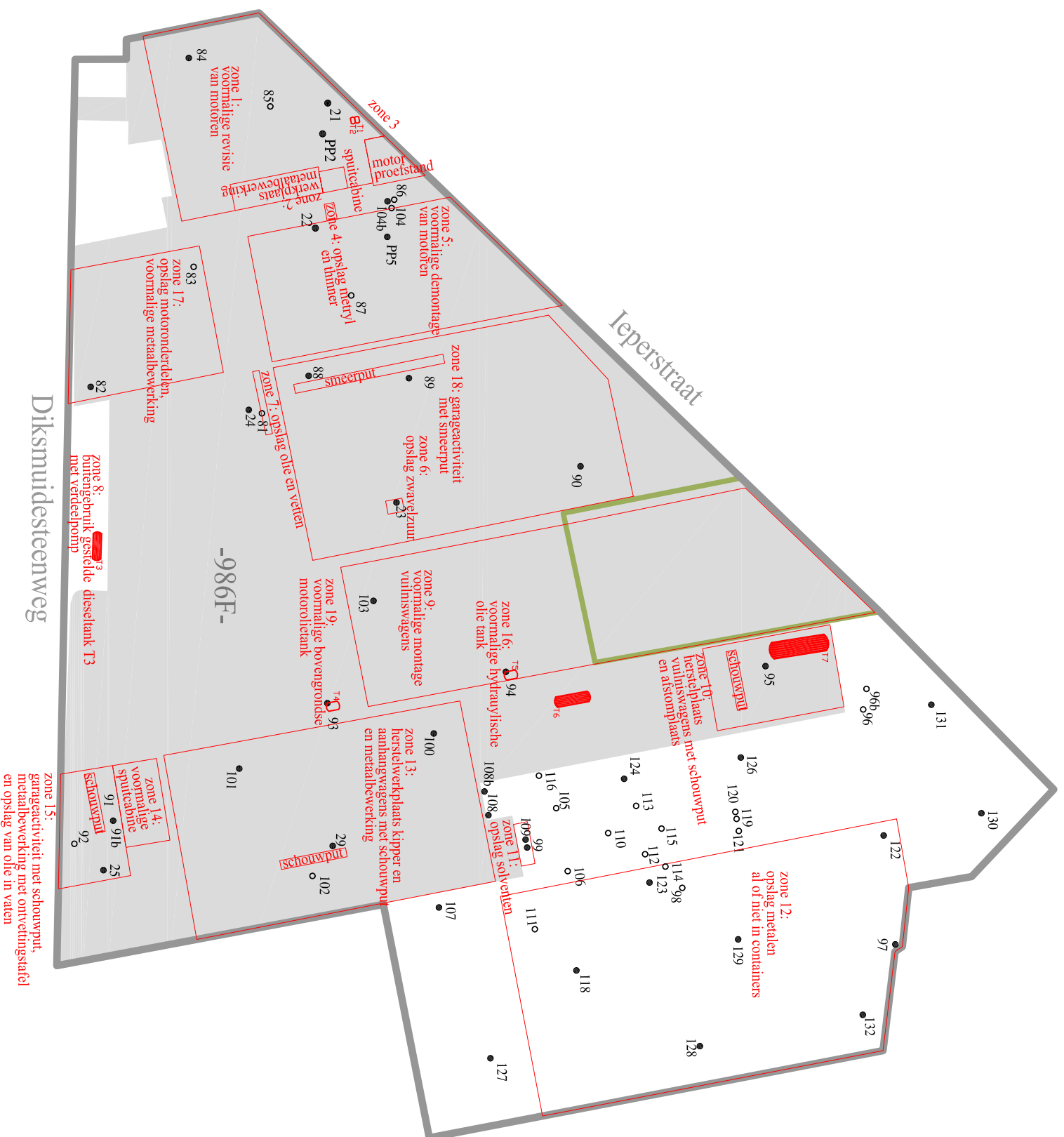
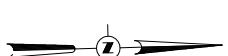

- LEGENDE**
- bovengrondse tank
 - ondergrondse tank
 - boring
 - peilput
 - contour perceel
 - contour kelder
 - contour gebouw

Detailplan

Oprichtgever	Mol Cy NV Diksmuidesteenweg 63
Onderzoeks-locatie	Mol Cy NV Diksmuidesteenweg 63 8830 Hooglede
Kenmerk dossier	C0372/D005-R01
Kenmerk plan	-
Datum	11/10/2012
Projectnr.	Els Spycckerelle

Schaal 1/800 op A3



Boring: 81

X: 57933
Y: 184288
Datum: 20-8-2012
Boormeester: Simon Depaepe

Boring: 82

X: 57929
Y: 184262
Datum: 20-8-2012
Boormeester: Simon Depaepe

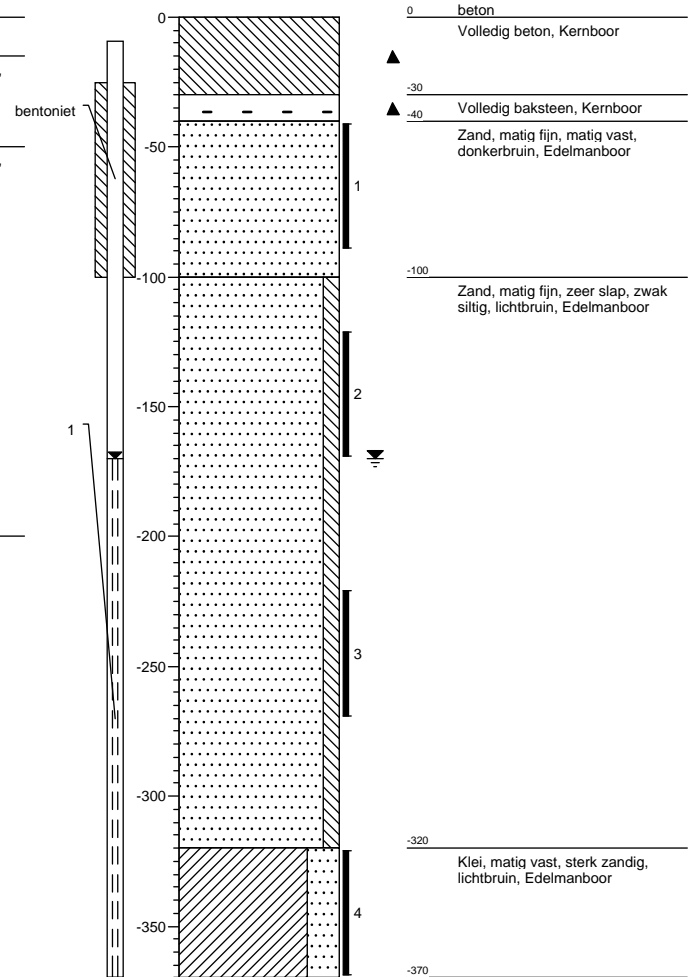
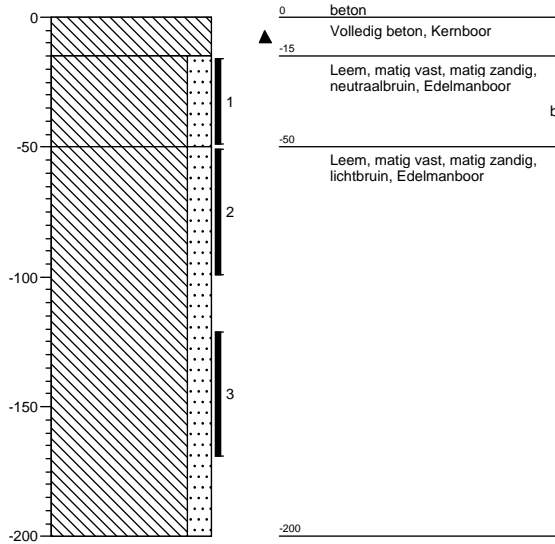

Boring: 83

X: 57911
Y: 184278
Datum: 20-8-2012
Boormeester: Simon Depaepe

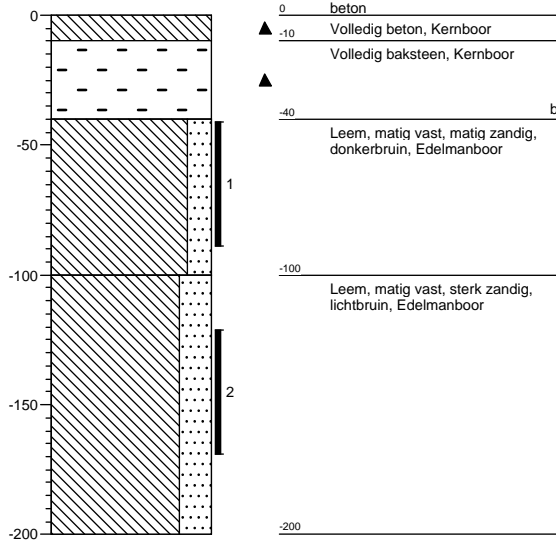

Boring: 84

X: 57929
Y: 184285
Datum: 20-8-2012
Boormeester: Simon Depaepe

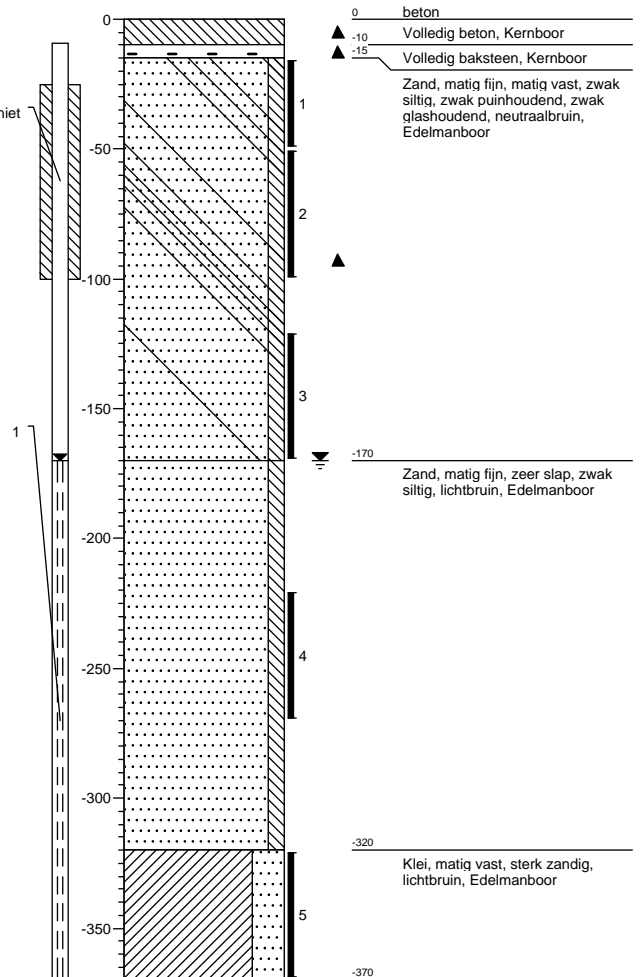

Boring: 85

X: 57887
 Y: 184289
 Datum: 20-8-2012
 Boormeester: Simon Depaepe

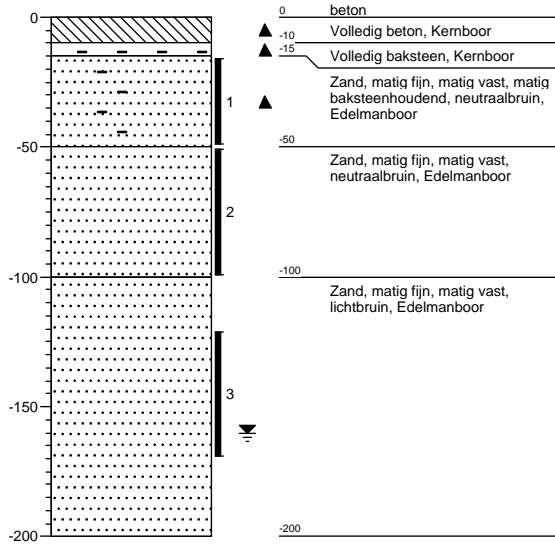
**Boring: 86**

X: 57901
 Y: 184308
 Datum: 20-8-2012
 Boormeester: Simon Depaepe

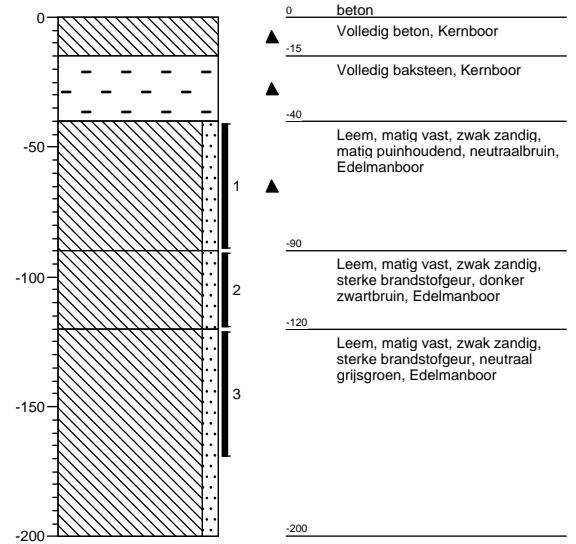

Boring: 87

X: 57915
Y: 184302
Datum: 20-8-2012
Boormeester: Simon Depaepe

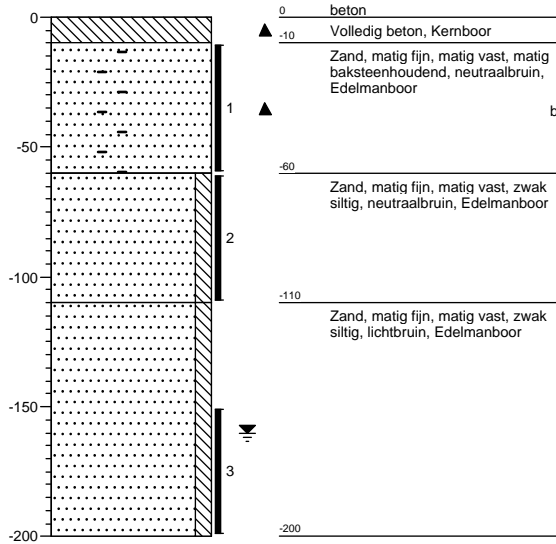

Boring: 88

X: 57927
Y: 184295
Datum: 20-8-2012
Boormeester: Simon Depaepe

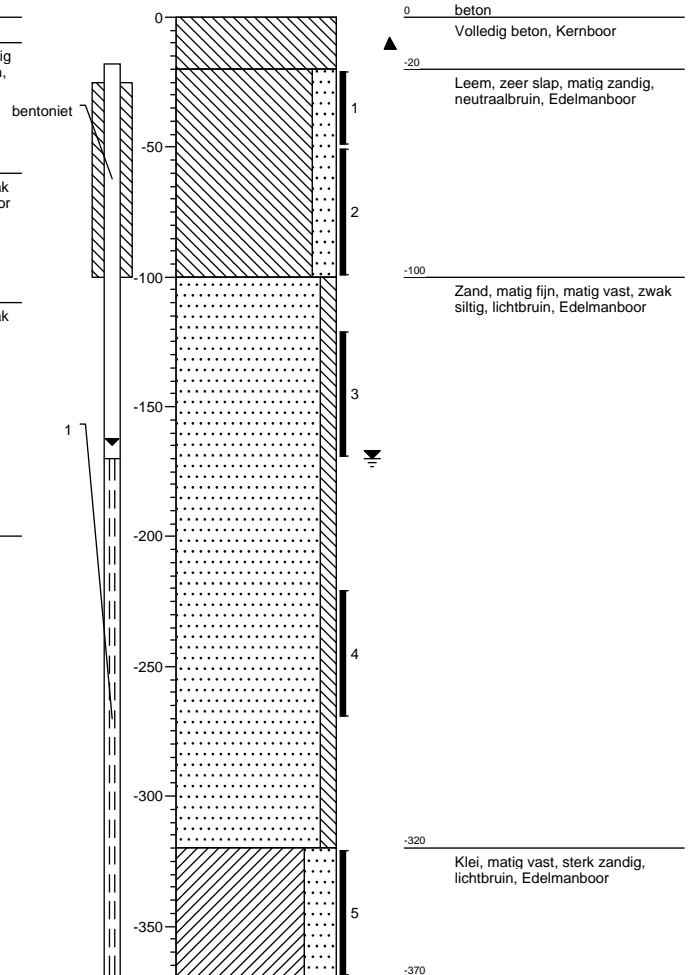

Boring: 89

X: 57928
Y: 184310
Datum: 20-8-2012
Boormeester: Simon Depaepe

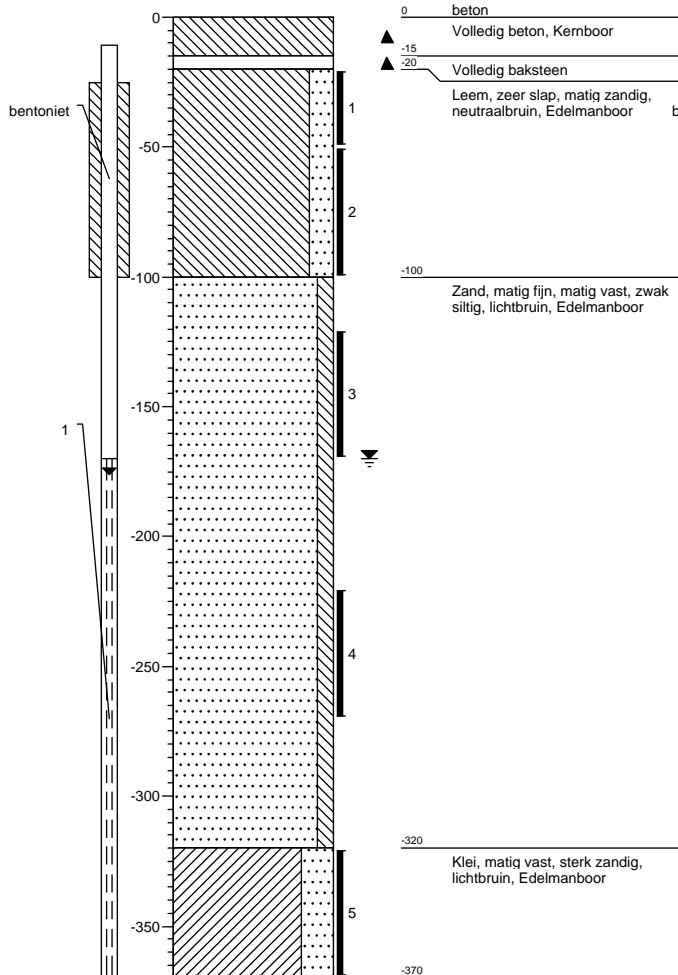

Boring: 90

X: 57928
Y: 184334
Datum: 20-8-2012
Boormeester: Simon Depaepe

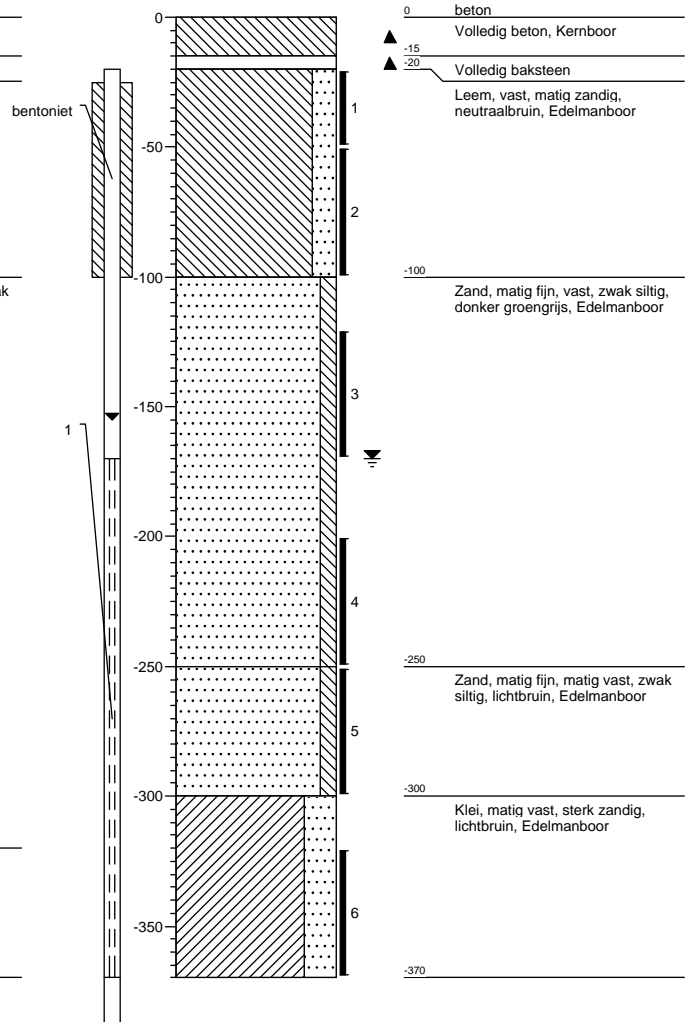

Boring: 91

X: 57989
Y: 184264
Datum: 21-8-2012
Boormeester: Simon Depaepe

Boring: 91b

X: 57994
Y: 184266
Datum: 23-8-2012
Boormeester: Simon Depaepe

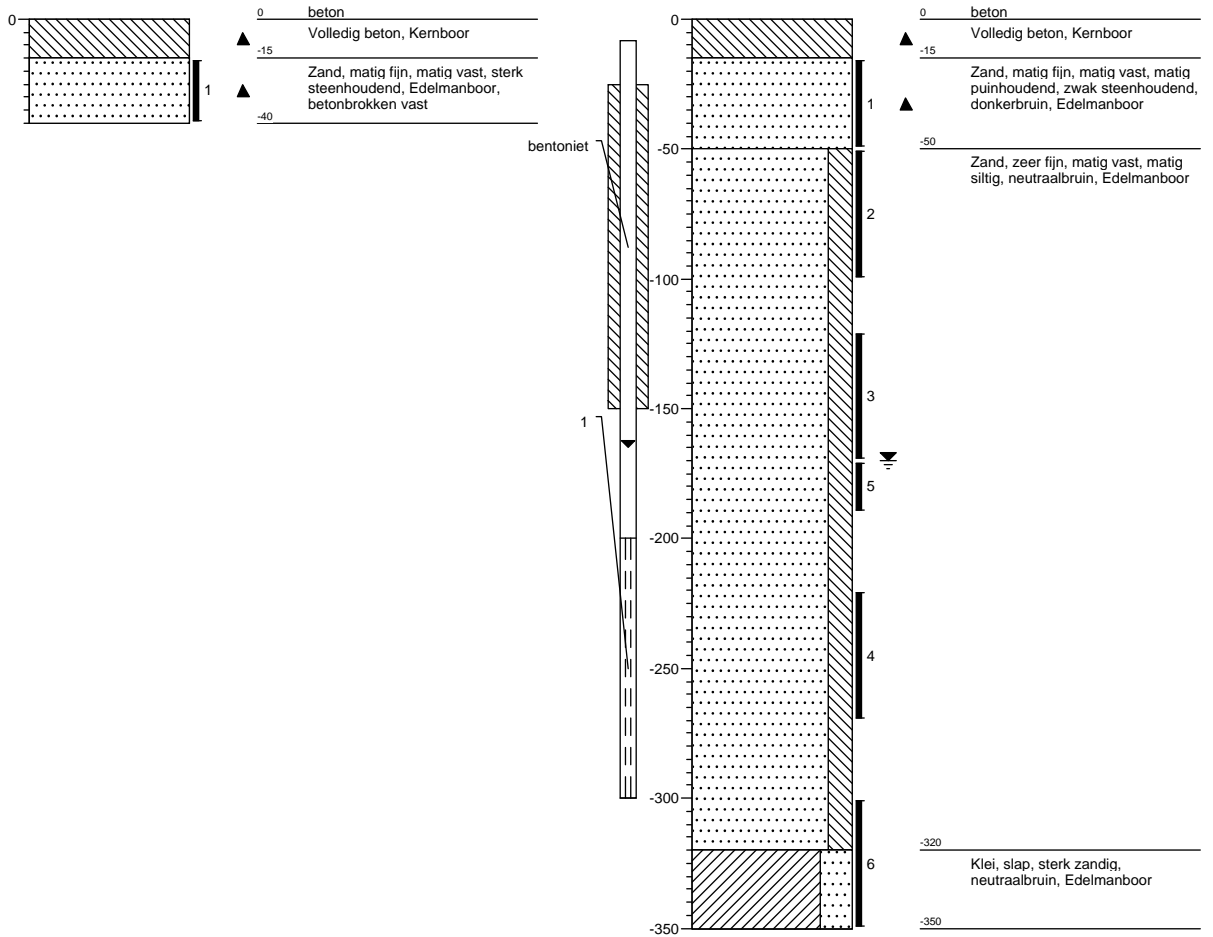

Boring: 92

X: 57998
Y: 184260
Datum: 23-8-2012
Boormeester: Simon Depaepe

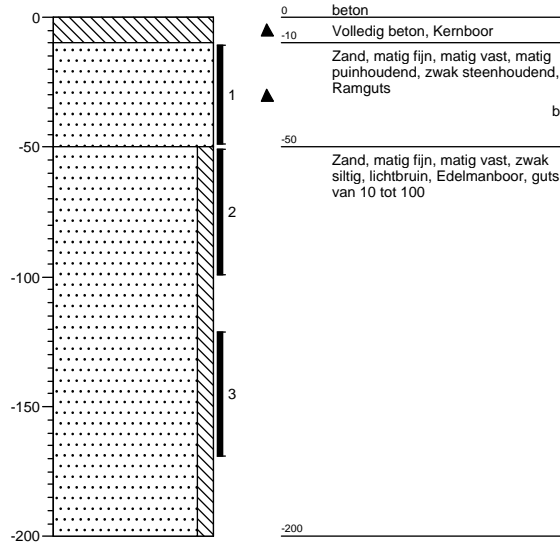

Boring: 93

X: 57977
Y: 184298
Datum: 20-8-2012
Boormeester: Simon Depaepe

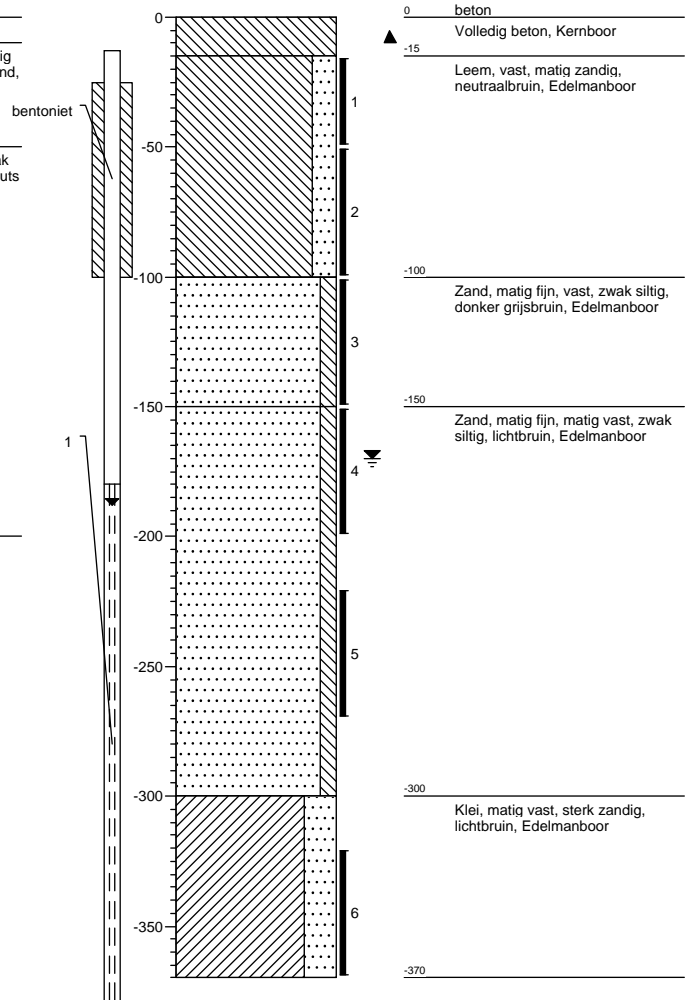

Boring: 94

X: 57972
Y: 184325
Datum: 20-8-2012
Boormeester: Simon Depaepe

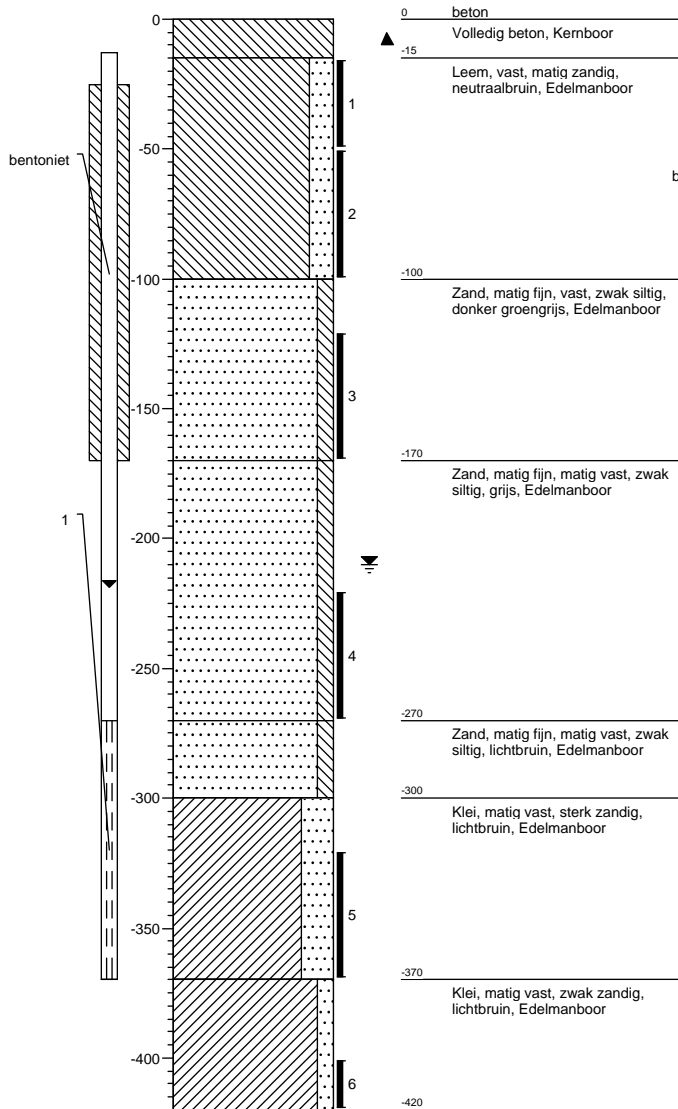

Boring: 95

X: 57971
Y: 184364
Datum: 21-8-2012
Boormeester: Simon Depaepe

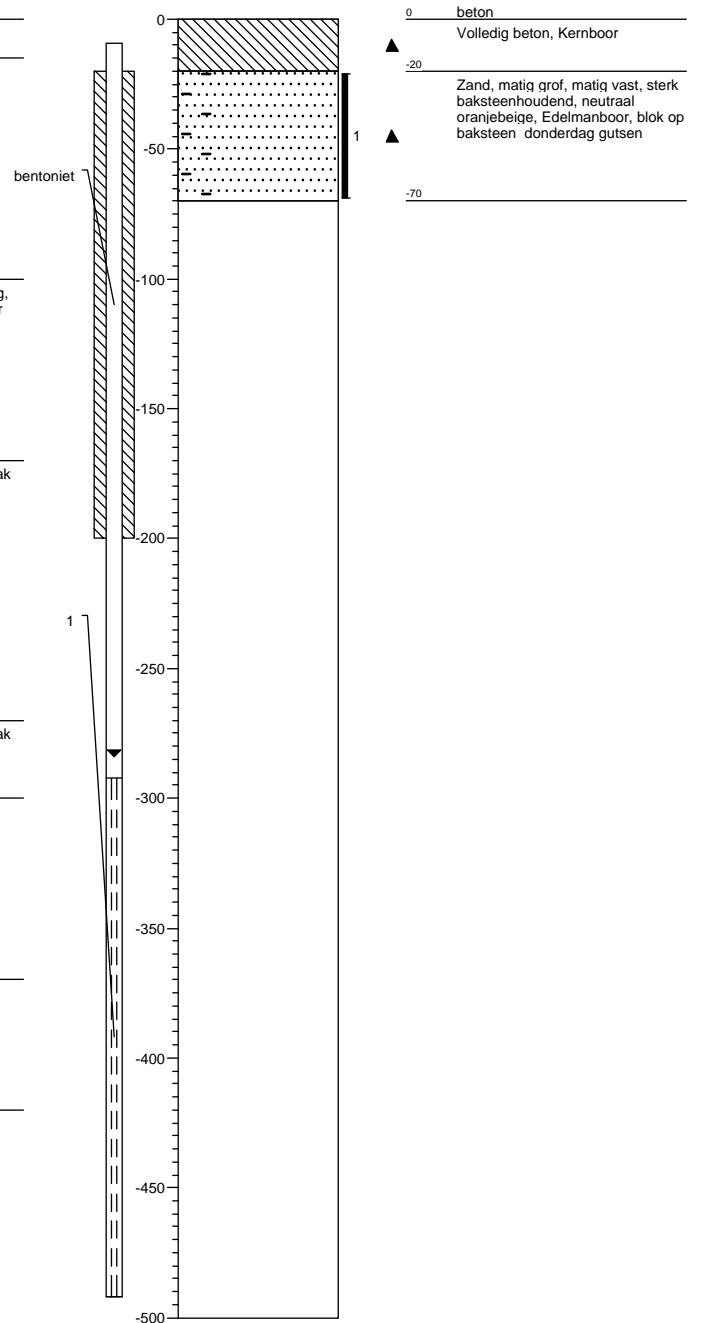

Boring: 96

X: 57978
Y: 184379
Datum: 23-8-2012
Boormeester: Simon Depaepe

Boring: 96b

X: 57974
Y: 184379
Datum: 23-8-2012
Boormeester: Simon Depaepe

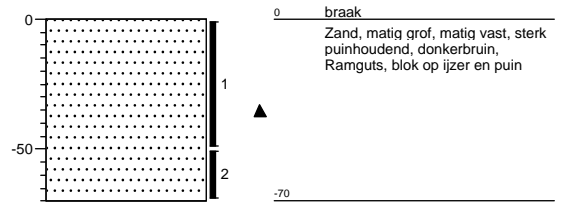
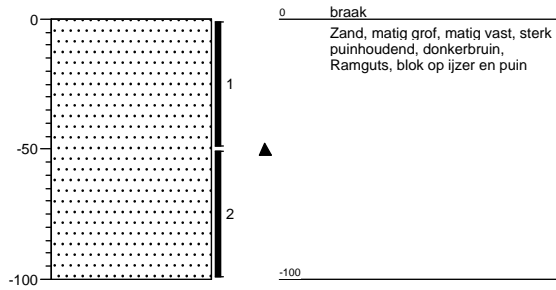

Boring: 97

X: 58013
Y: 184384
Datum: 23-8-2012
Boormeester: Simon Depaepe

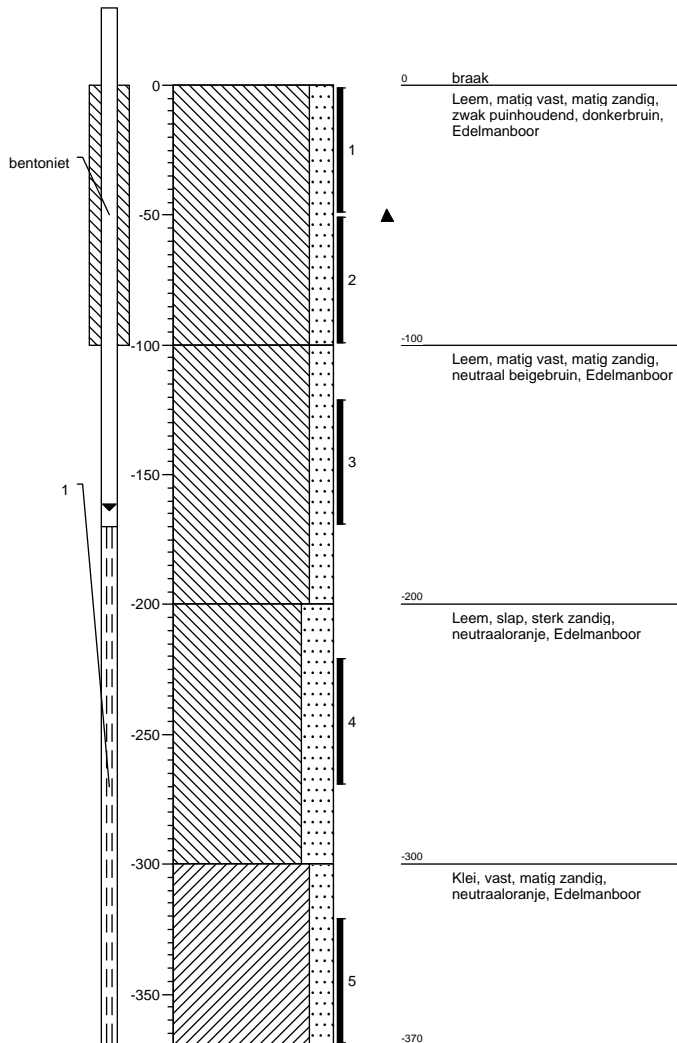

Boring: 98

X: 58004
Y: 184351
Datum: 23-8-2012
Boormeester: Simon Depaepe

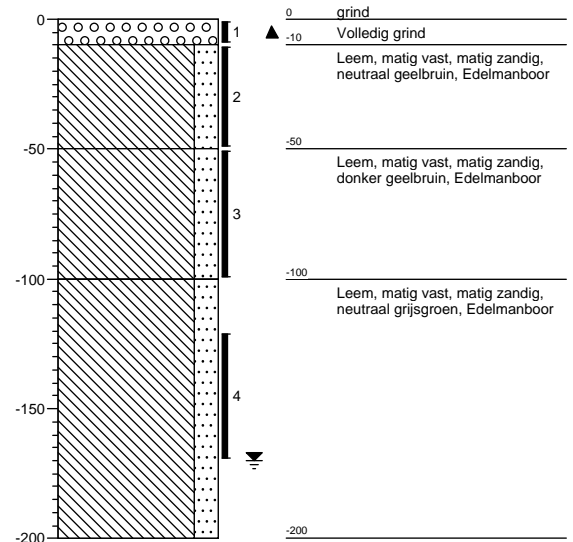

Boring: 99

X: 57998
 Y: 184328
 Datum: 23-8-2012
 Boormeester: Simon Depaepe

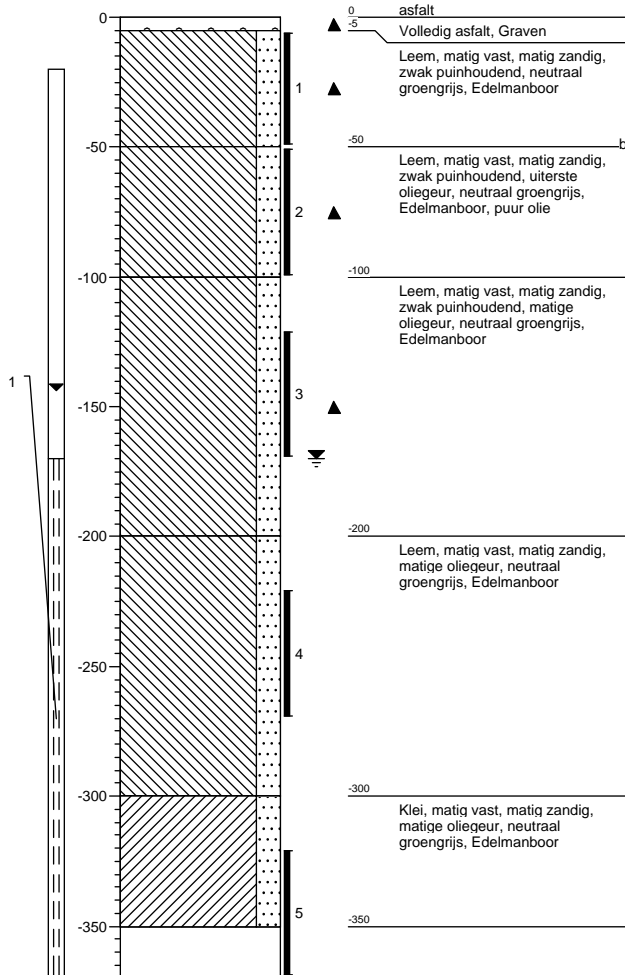
**Boring: 100**

X: 57981
 Y: 184314
 Datum: 21-8-2012
 Boormeester: Simon Depaepe

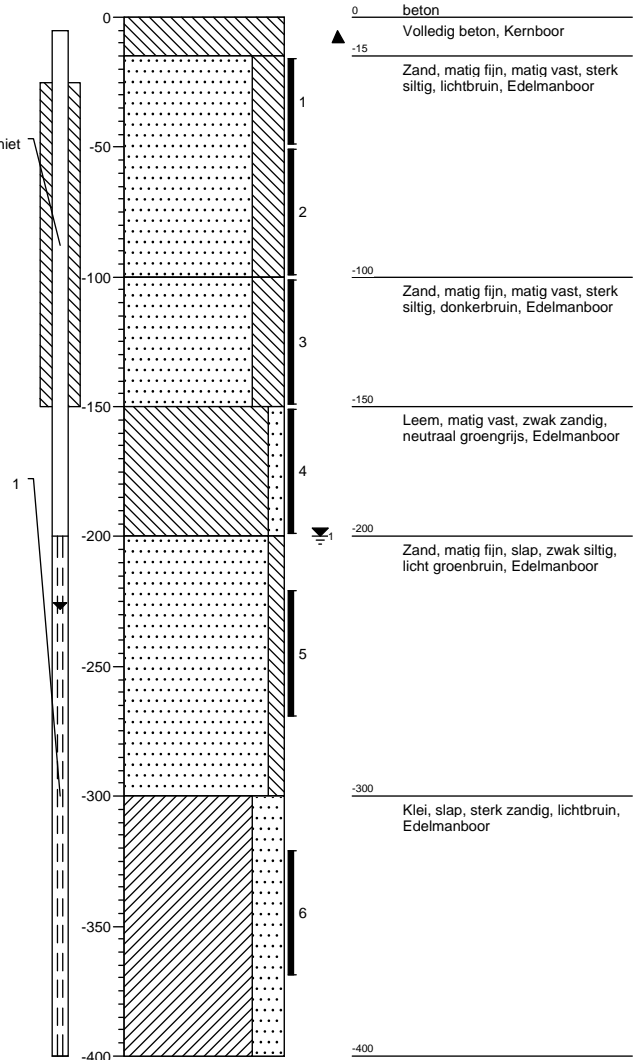

Boring: 101

X: 57986
Y: 184285
Datum: 23-8-2012
Boormeester: Simon Depaepe

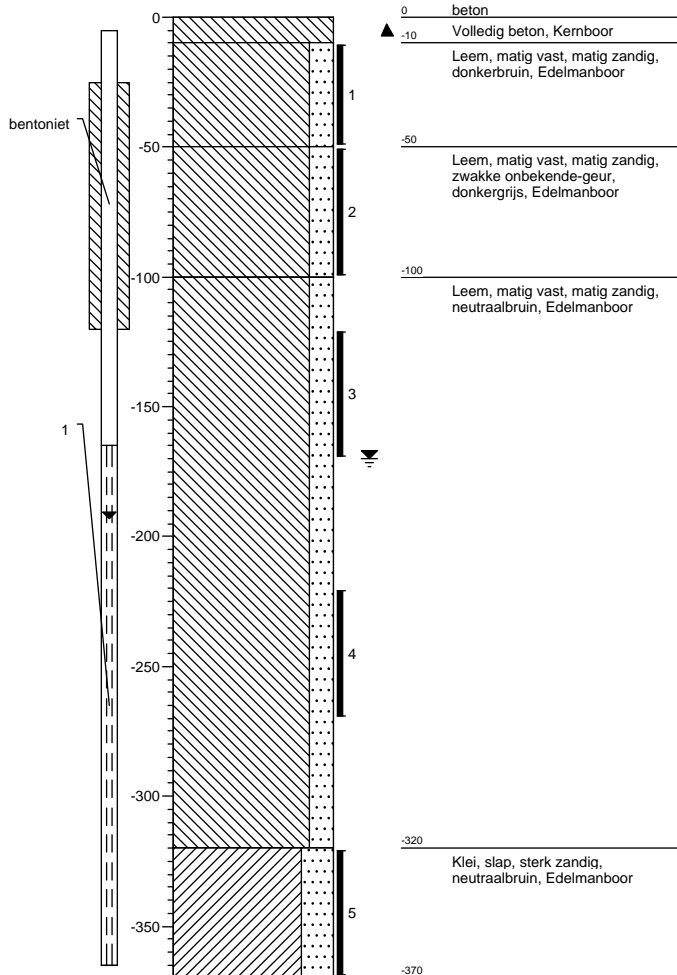

Boring: 102

X: 58002
Y: 184296
Datum: 21-8-2012
Boormeester: Simon Depaepe

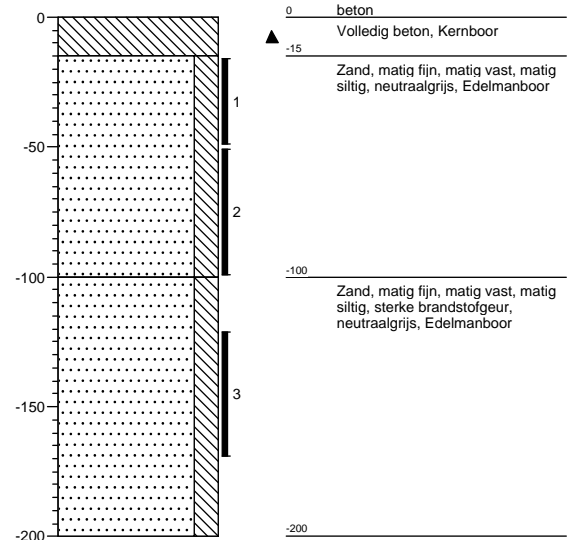

Boring: 103

X: 57961
Y: 184305
Datum: 21-8-2012
Boormeester: Simon Depaepe

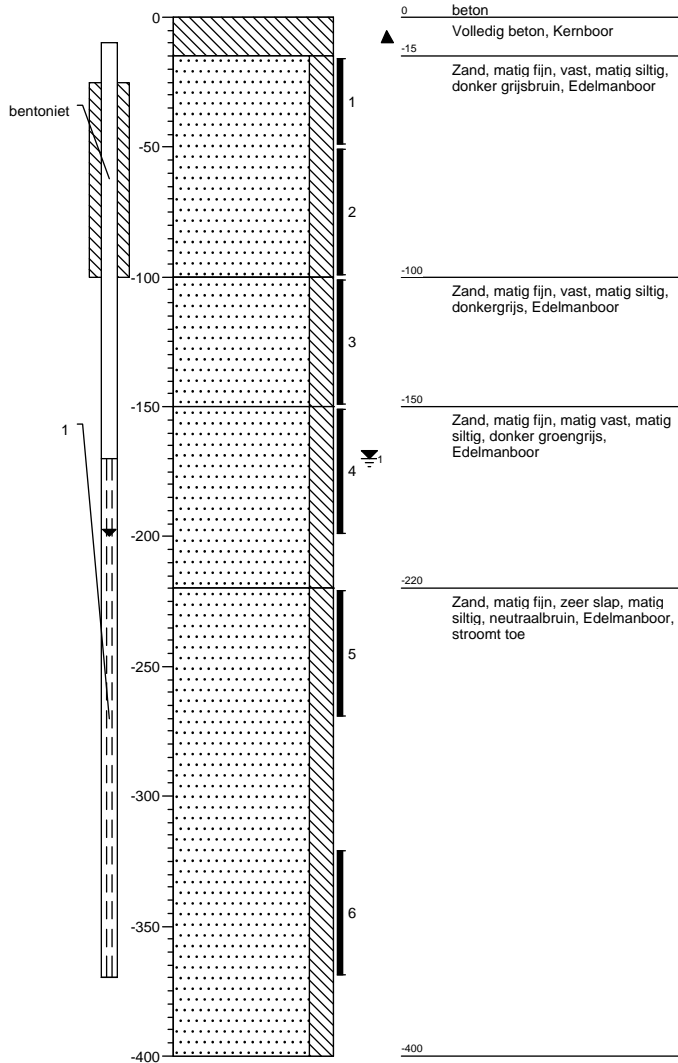

Boring: 104

X: 57901
Y: 184308
Datum: 2-10-2012
Boormeester: Simon Depaepe

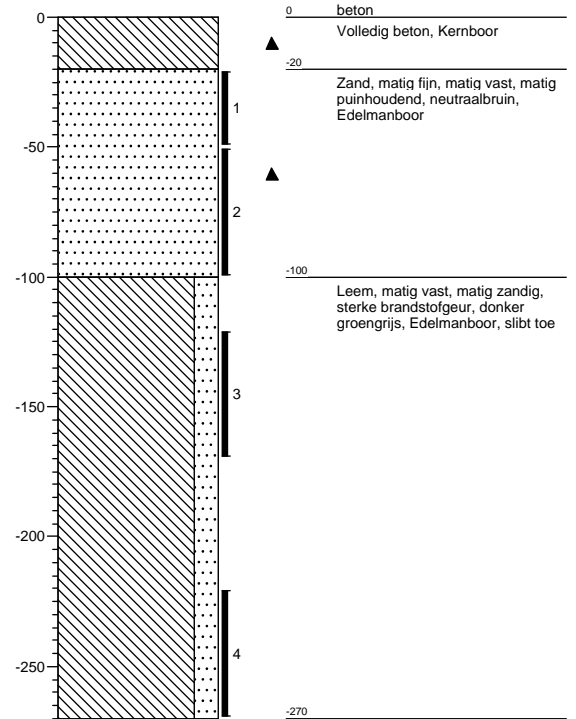

Boring: 104b

X: 57902
Y: 184308
Datum: 9-10-2012
Boormeester: Simon Depaepe

26,66

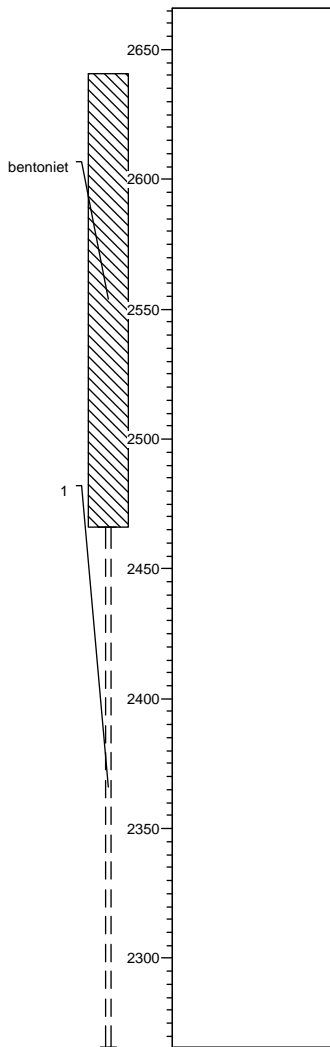

2666 beton
Machinale Peilbuis

2266



Boring: 105

X: 57992
Y: 184332
Datum: 2-10-2012
Boormeester: Simon Depaepe

Boring: 106

X: 58001
Y: 184334
Datum: 2-10-2012
Boormeester: Simon Depaepe

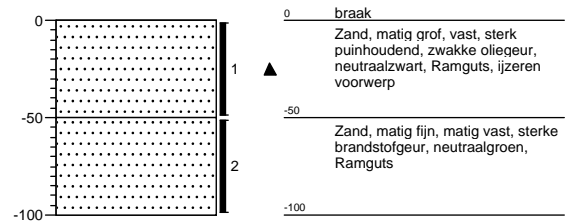
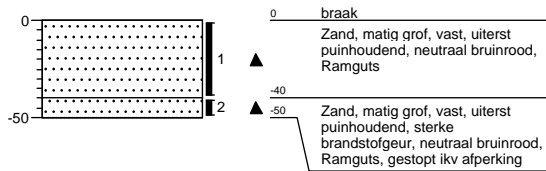

Boring: 107

X: 58007
 Y: 184315
 Datum: 2-10-2012
 Boormeester: Simon Depaepe

Boring: 108

X: 57993
 Y: 184322
 Datum: 2-10-2012
 Boormeester: Simon Depaepe

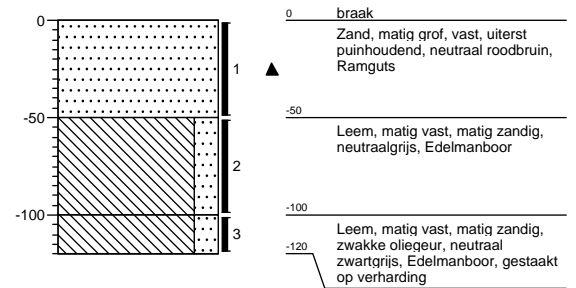
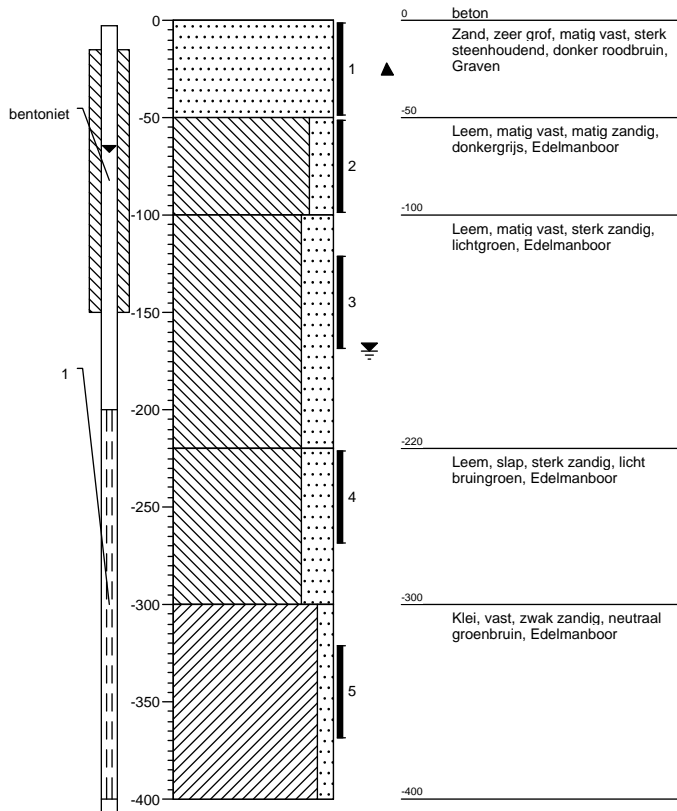

Boring: 108b

X: 57989
Y: 184321
Datum: 2-10-2012
Boormeester: Simon Depaepe

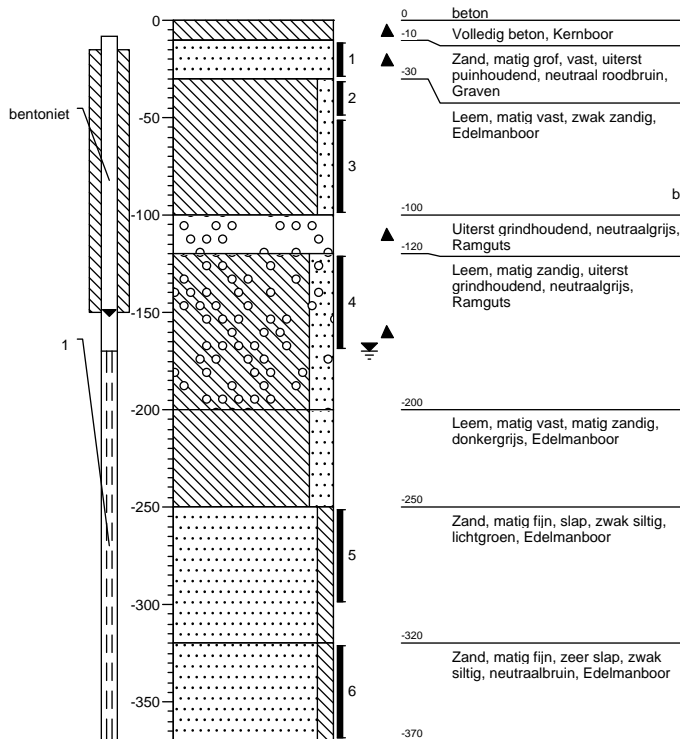

Boring: 109

X: 57997
Y: 184327
Datum: 19-10-2012
Boormeester: Simon Depaepe

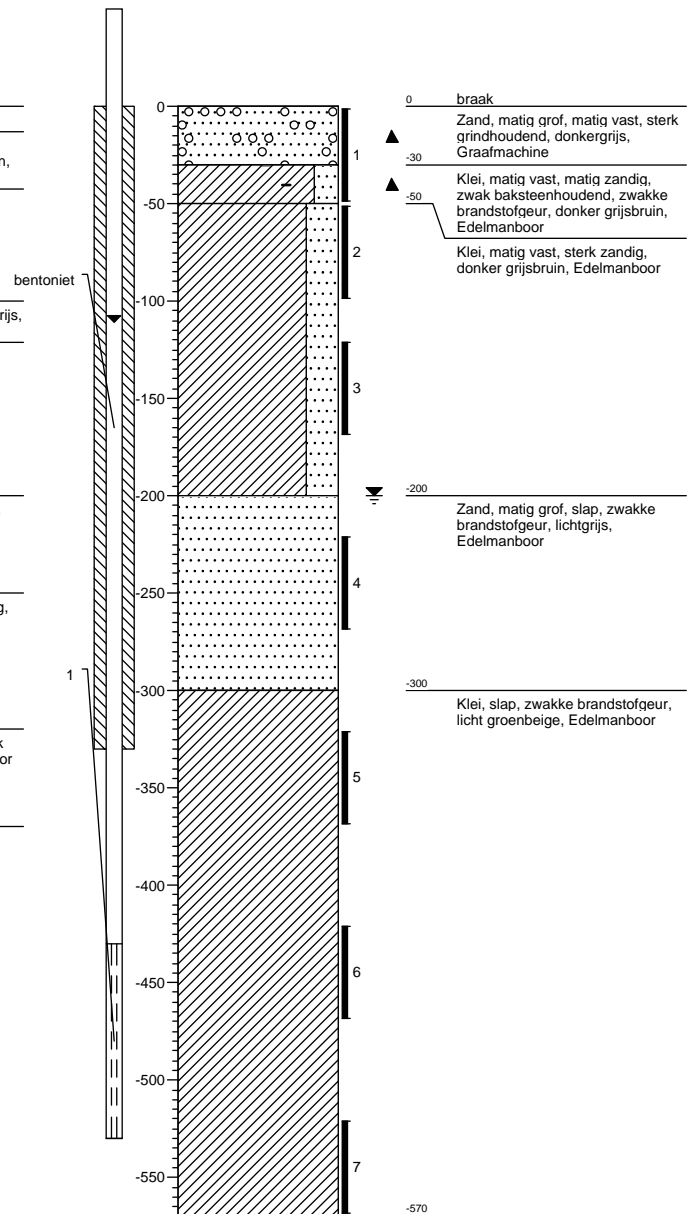

Boring: 110

X: 57996
Y: 184340
Datum: 15-10-2012
Boormeester: Simon Depaepe

Boring: 111

X: 58010
Y: 184329
Datum: 15-10-2012
Boormeester: Simon Depaepe

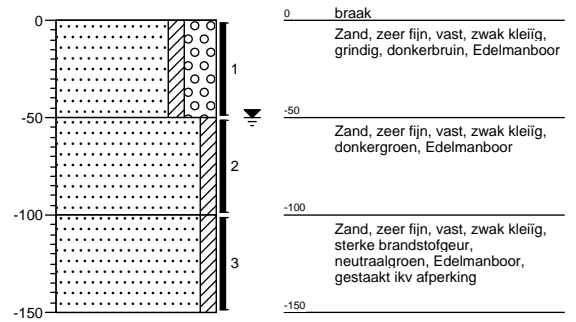
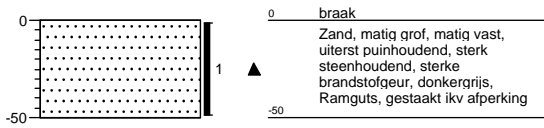

Boring: 112

X: 57999
Y: 184345
Datum: 15-10-2012
Boormeester: Simon Depaepe

Boring: 113

X: 57992
Y: 184344
Datum: 15-10-2012
Boormeester: Simon Depaepe

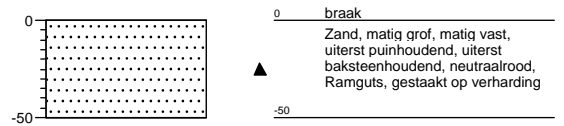
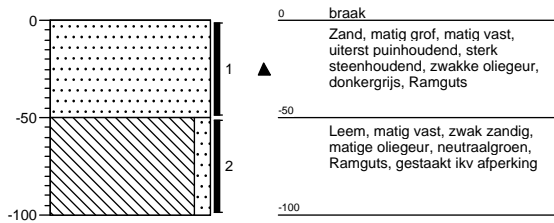

Boring: 114

X: 58001
Y: 184348
Datum: 15-10-2012
Boormeester: Simon Depaepe

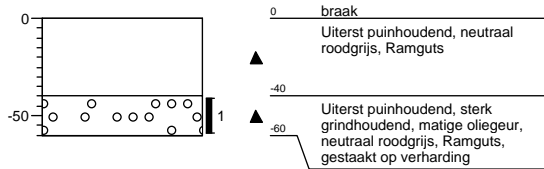

Boring: 115

X: 57995
Y: 184348
Datum: 15-10-2012
Boormeester: Simon Depaepe

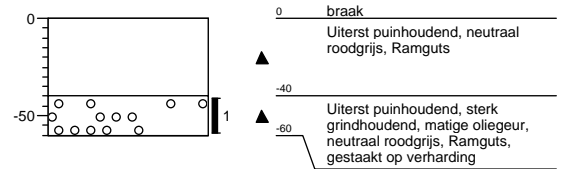

Boring: 118

X: 58016
Y: 184335
Datum: 19-10-2012
Boormeester: Simon Depaepe

Boring: 119

X: 57994
Y: 184359
Datum: 15-10-2012
Boormeester: Simon Depaepe

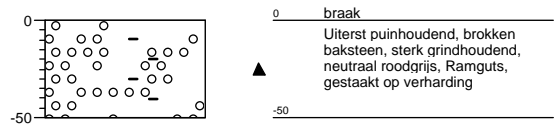
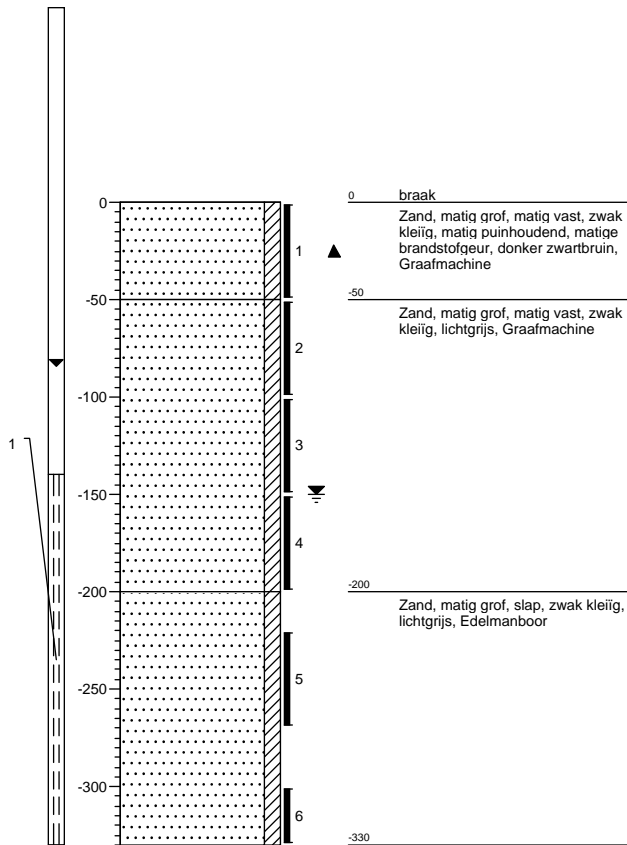

Boring: 120

X: 57993
Y: 184359
Datum: 15-10-2012
Boormeester: Simon Depaepe

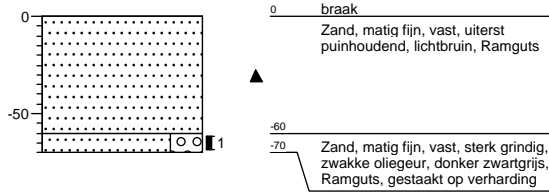

Boring: 121

X: 57995
Y: 184359
Datum: 15-10-2012
Boormeester: Simon Depaepe

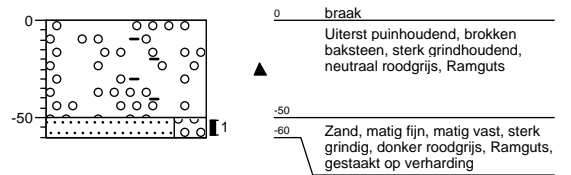

Boring: 122

X: 57996
Y: 184381
Datum: 19-10-2012
Boormeester: Simon Depaepe

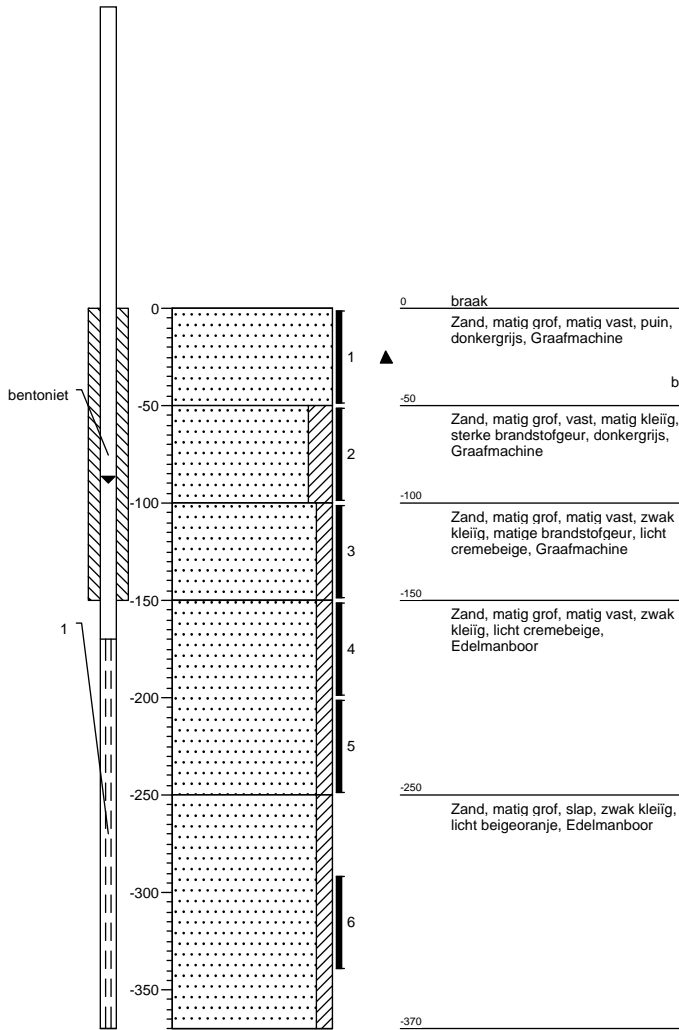

Boring: 123

X: 58003
Y: 184346
Datum: 8-11-2012
Boormeester: Simon Depaepe

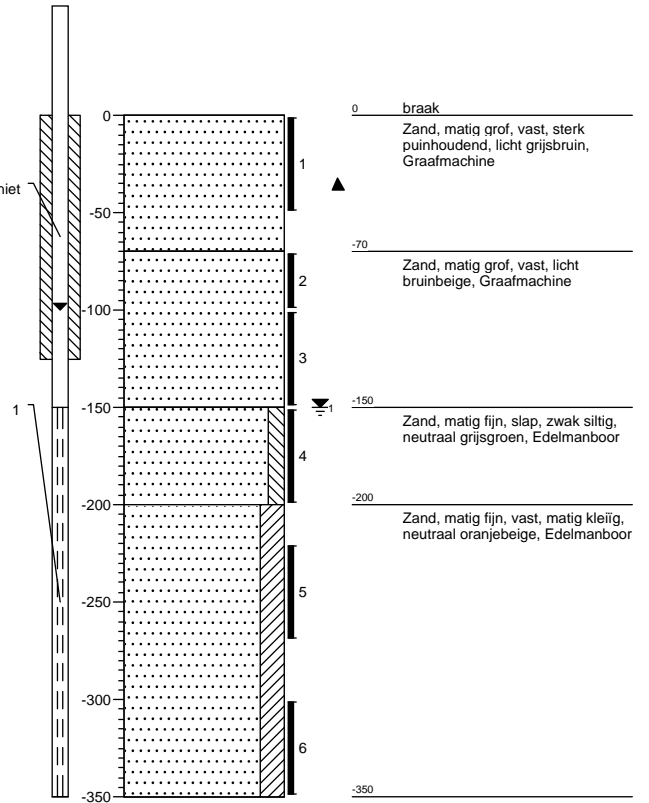

Boring: 124

X: 57988
Y: 184342
Datum: 8-11-2012
Boormeester: Simon Depaepe

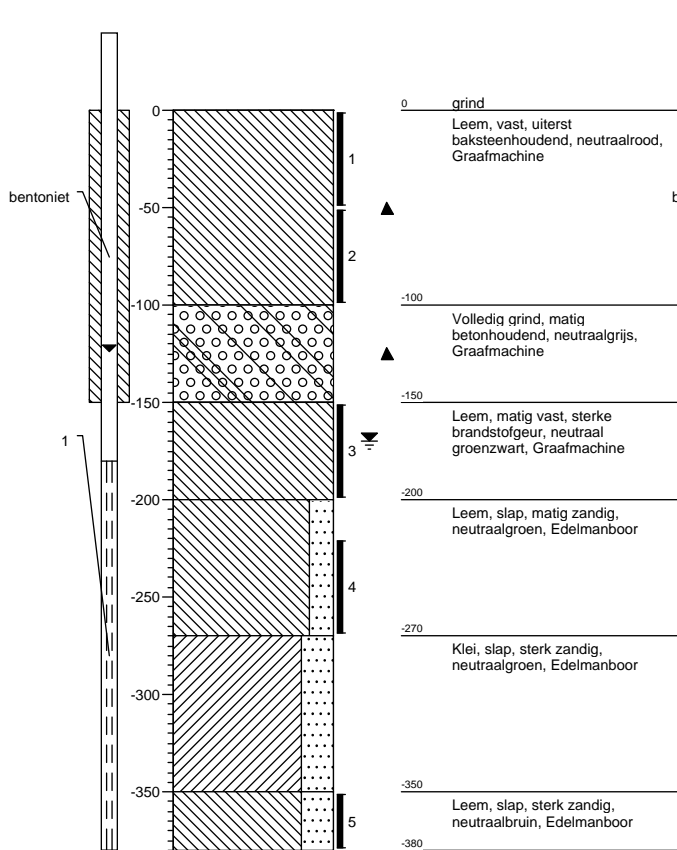

Boring: 126

X: 57985
Y: 184360
Datum: 8-11-2012
Boormeester: Simon Depaepe

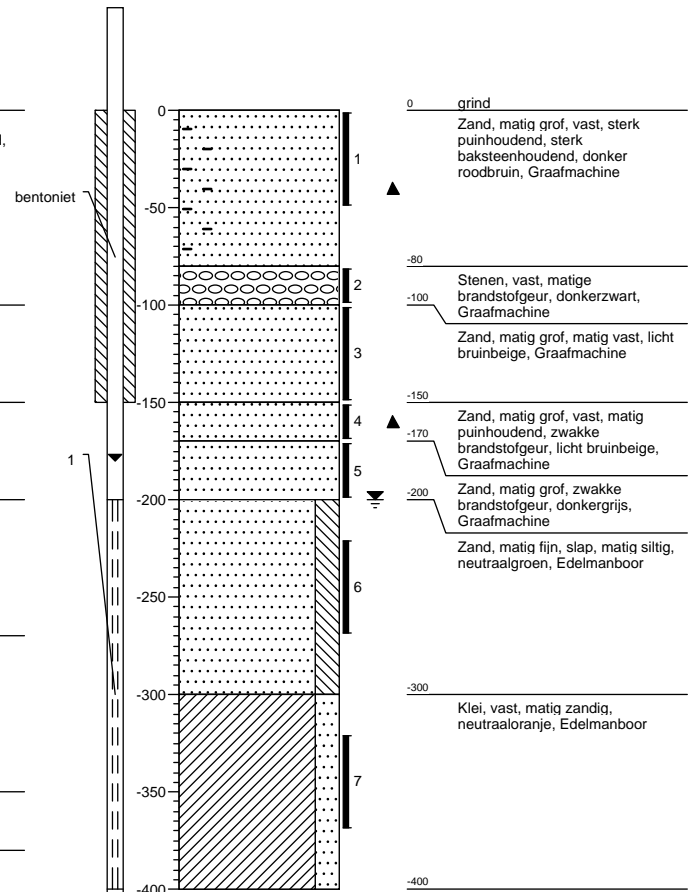

Boring: 124

X: 57988
Y: 184342
Datum: 8-11-2012
Boormeester: Simon Depaepe

Boring: 126

X: 57985
Y: 184360
Datum: 8-11-2012
Boormeester: Simon Depaepe

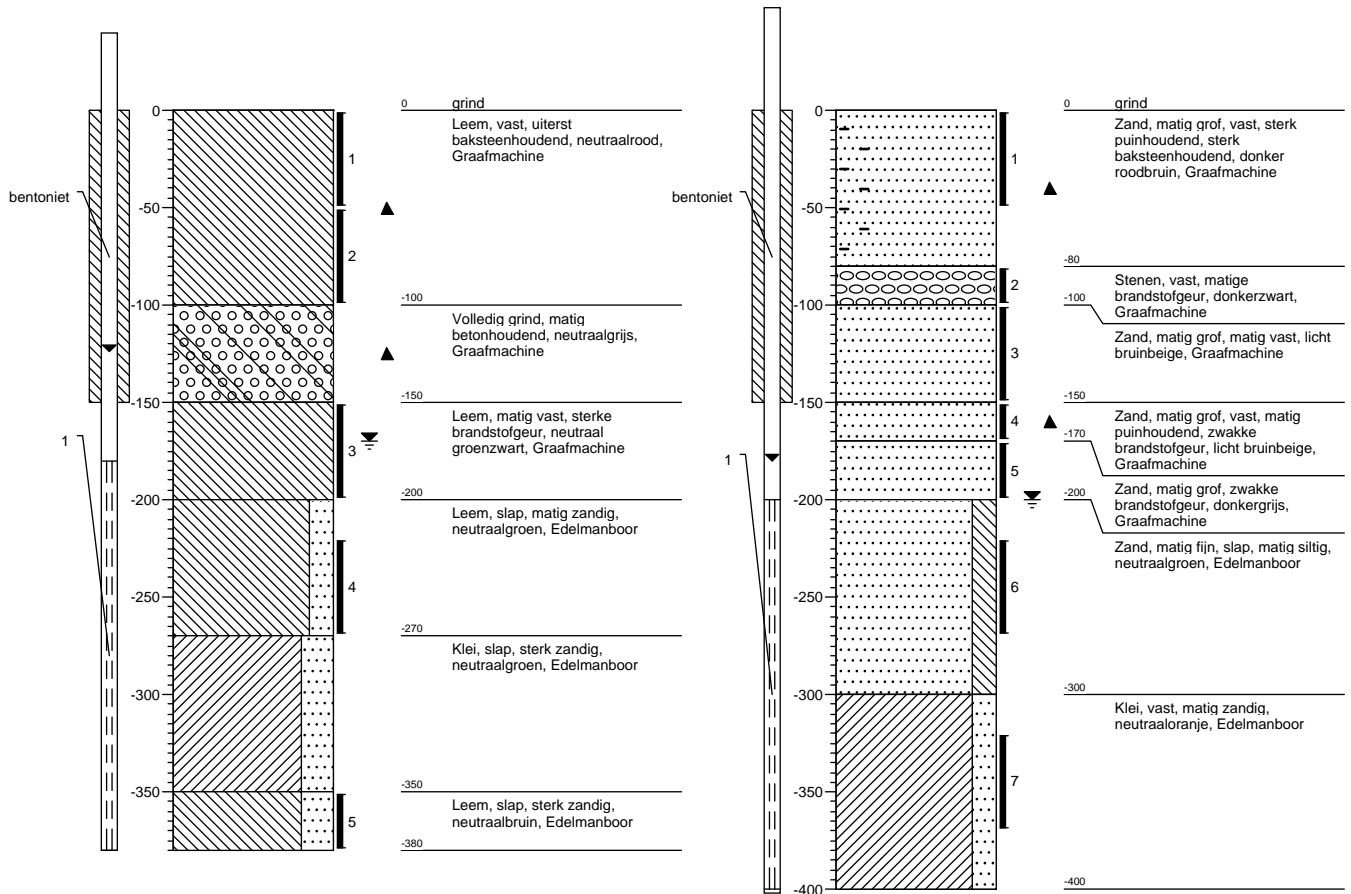

Boring: 127

X: 58030
Y: 184322
Datum: 19-10-2012
Boormeester: Simon Depaepe

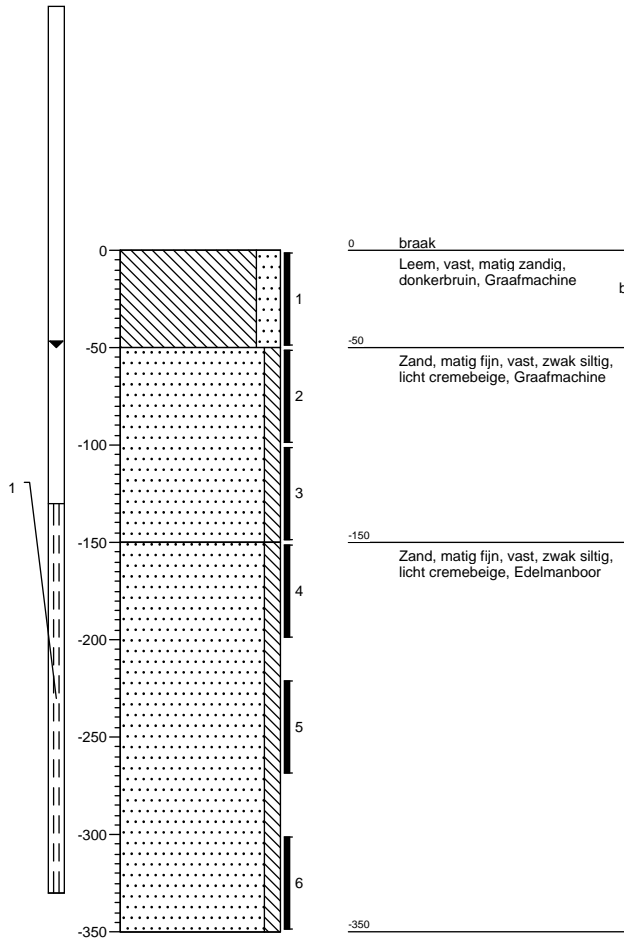

Boring: 128

X: 58028
Y: 184354
Datum: 19-10-2012
Boormeester: Simon Depaepe

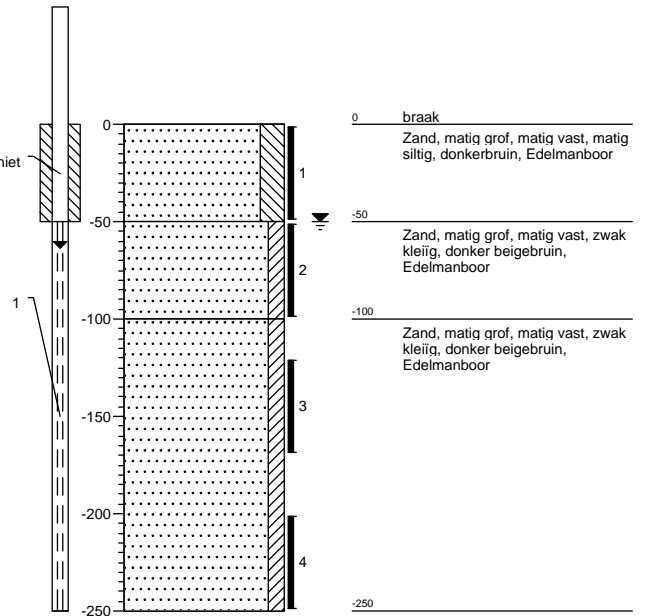

Boring: 129

X: 58012
 Y: 184359
 Datum: 8-11-2012
 Boormeester: Simon Depaepe

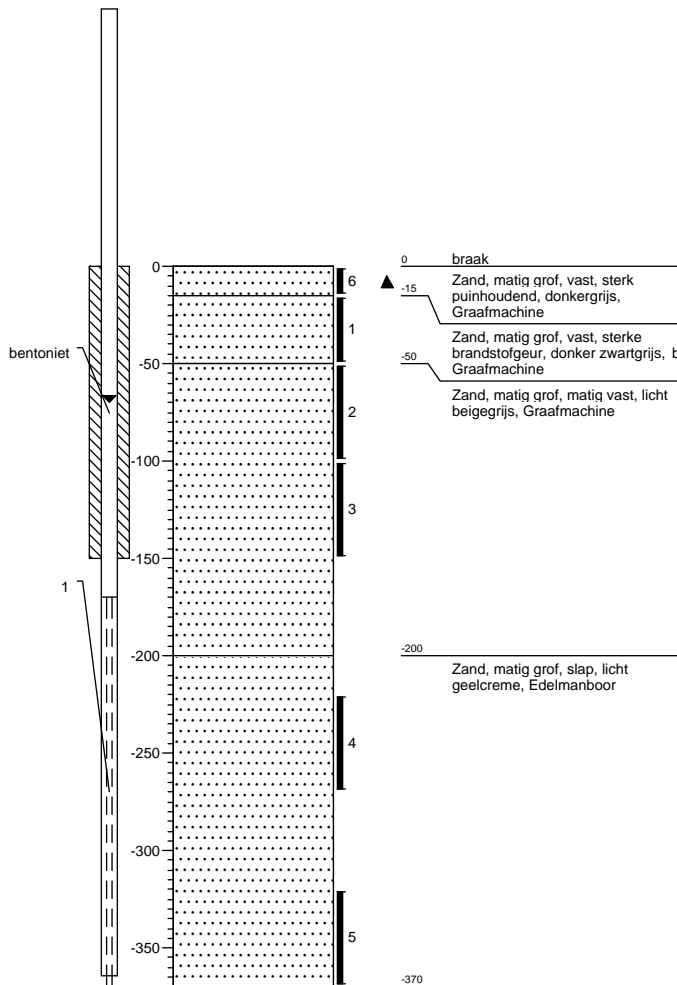
**Boring: 130**

X: 57993
 Y: 184397
 Datum: 19-10-2012
 Boormeester: Simon Depaepe

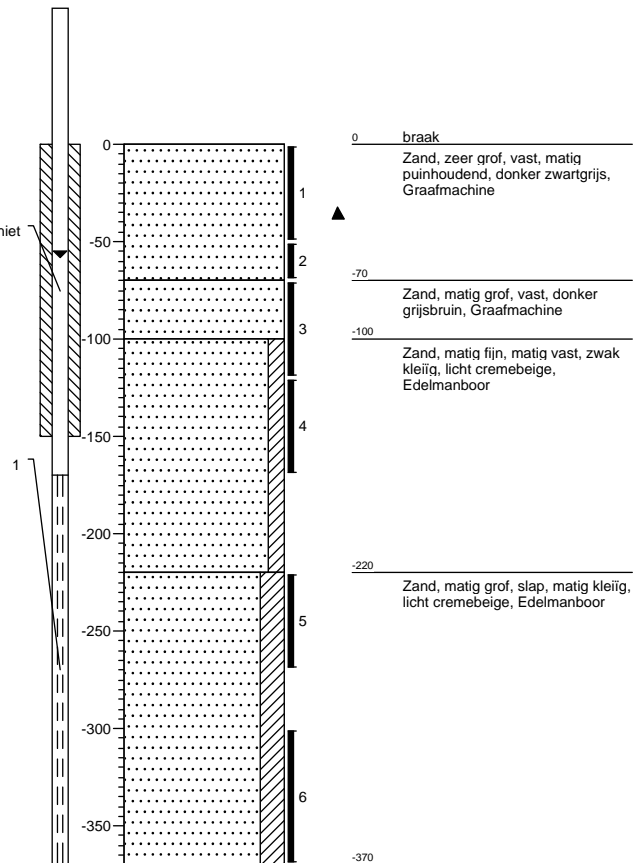

Boring: 131

X: 57977
Y: 184389
Datum: 8-11-2012
Boormeester: Simon Depaepe

Boring: 132

X: 58023
Y: 184379
Datum: 19-10-2012
Boormeester: Simon Depaepe

